

Answers to CAD Problems

1.

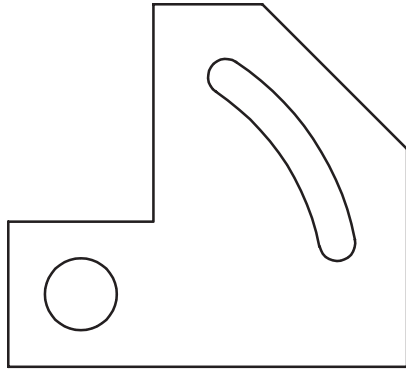

2.

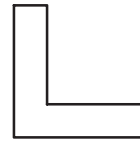
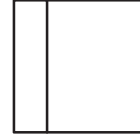

3.

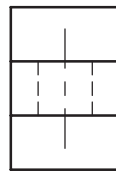
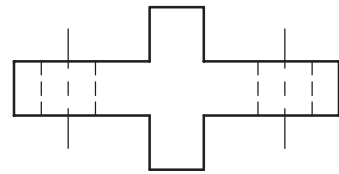
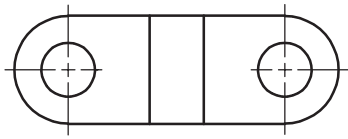

4.

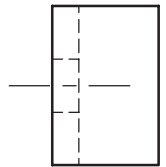
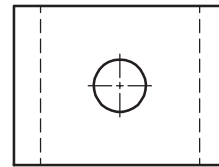
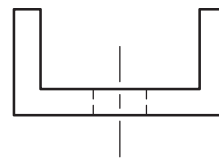

5.

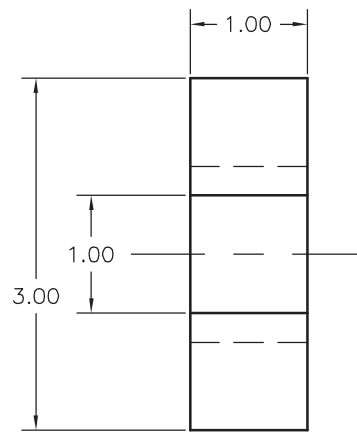
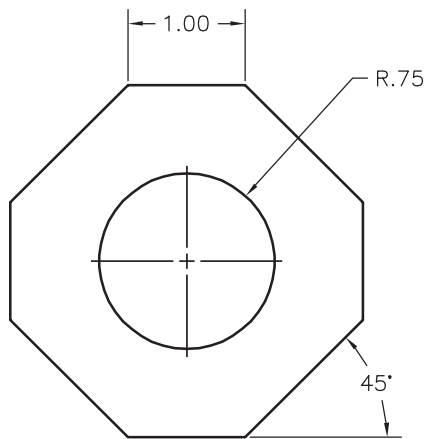



Answers to CAD Problems

5.